

Versatile logic test probe

If you work or experiment with logic circuitry this project should be invaluable for debugging circuits. Inexpensive to build, it may be used both with TTL and CMOS circuitry, and indicates HI or LO conditions as well as pulse trains above 1 MHz. It will also detect short, isolated pulses having widths down to 500 ns.

Dr P.M. Kelly

INTEREST in digital electronics has grown rapidly in the past few years with the advent of microprocessors and large scale integration. The most essential test instrument for experimenting with digital circuitry is a logic probe.

In its most basic form this should provide an indication of the logic level at any point in a circuit without overloading the section being tested. Other desirable features are the ability to follow high frequency pulse trains (preferably over 1 MHz) and to detect isolated, narrow pulses less than 1 μ sec in width. Finally, the instrument should be compatible with both TTL and CMOS ICs and be able to operate from a wide range of supply voltages (say five to 15 volts).

Commercial logic probes that satisfy all these requirements are available, but they invariably cost over \$30. The probe design described here offers comparable performance for less than \$5, combined with an excuse to enjoy a good cigar — a cigar tube is used for the case!

Indication is by means of three LEDs. Two red LEDs indicate either a HIGH or a LOW condition on the point under test, a green LED is used to indicate that a pulse train is occurring.

The circuit uses a single CMOS IC and a handful of resistors and capacitors. The components are mounted on a small pc board and housed in a tubular case such as an aluminium cigar tube or a length of plastic conduit. The power is supplied from the actual circuit under test and the performance characteristics of the prototype are described in the specification listed here. ▶

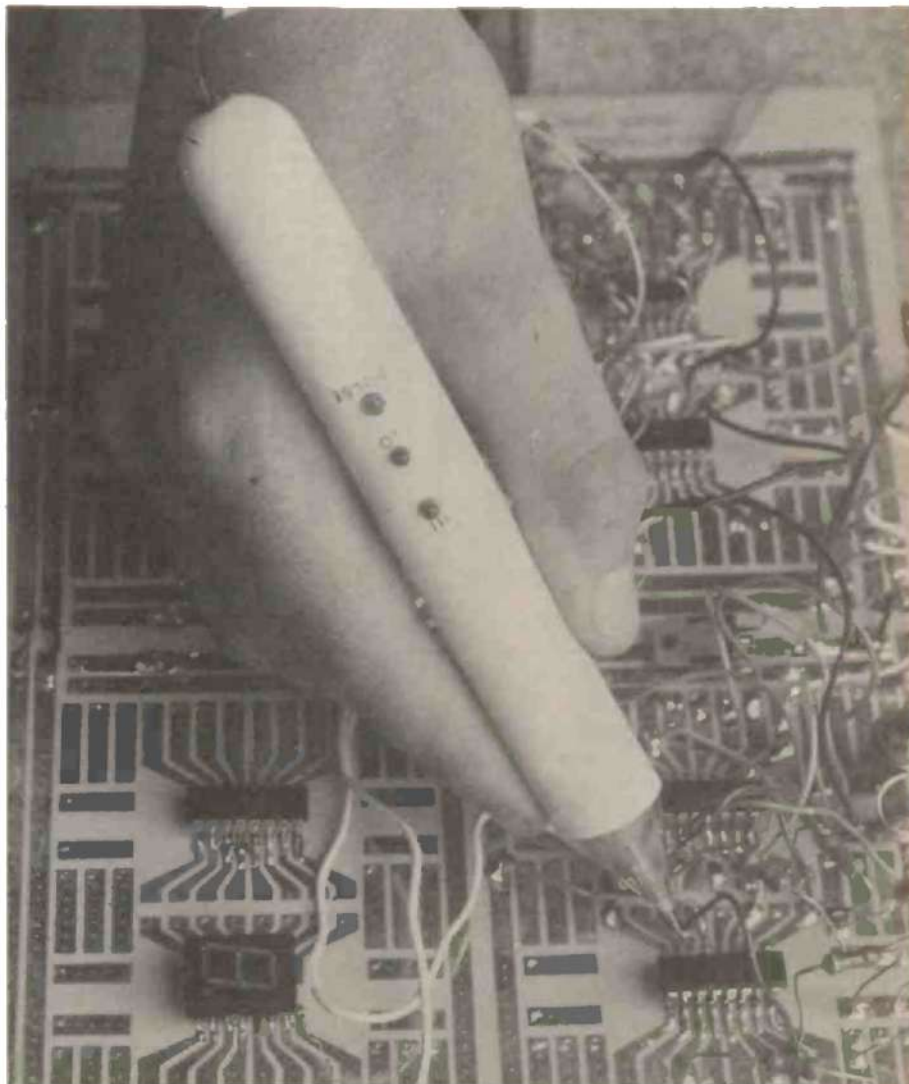

A logic probe is an invaluable aid for debugging or servicing digital circuitry. This project is inexpensive and easy to build.

Project 148

The circuit is simple, involves a single CMOS IC, three LEDs and a handful of other components.

SPECIFICATION ETI-148

- TTL or CMOS compatible
- Supply voltage: 5 to 15 volts
- Input impedance: over 400k
- Indicates HIGH (1), LOW (0) or floating states
- Follows high frequency pulse trains — over 1.5 MHz
- Detects single pulses down to 500 nsec in width, and stretches these to 15 msec.
- Relative brightness of HIGH/LOW LEDs indicates duty cycle of pulse trains.

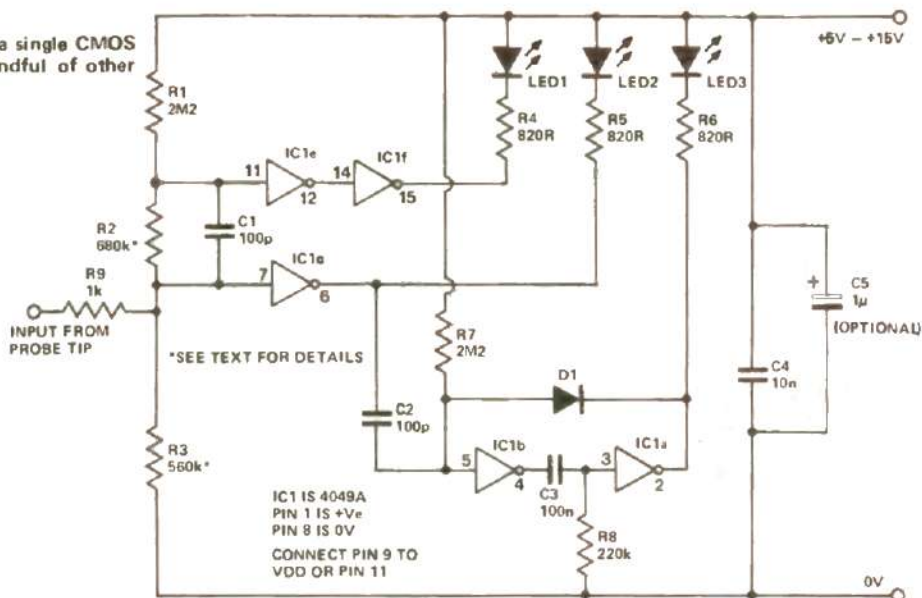

Construction

A printed circuit board is recommended for this project to provide consistent performance characteristics.

Before attempting to mount the components on the printed circuit board check to see that it fits easily into the case. The board must be a loose enough fit to allow it to be moved up and down within the case over a range of at least 5 mm. (Refer to the diagram).

If this is not possible, the width of the board can be reduced slightly with a file or coarse sandpaper, taking care not to remove too much or to damage the copper portions of the board.

The other alternative is to use a larger case — buy a bigger cigar! This movement within the case is necessary so that the LEDs can be juggled into position in the holes in the casing (see later).

Mount the wire links, the resistors and the capacitors on the pc board, keeping all components as close to the board as possible. Note that C3 is mounted on the underside of the board. Next, install the three LEDs. The height of the LEDs above the pc board must be such that the assembly will slide into the case with the board pushed down against the bottom of the case (see diagram). For a 20 mm diameter case this height should be about 12 mm. If the LEDs are not high enough, then it will not be possible to push the assembled board up into a position where the LEDs project through the holes in the case.

Next, add the power leads (without clips or E-Z hooks at this stage) and the 10 cm wire to the probe tip. Last of all

solder IC1 into position, observing all the usual precautions — shorted pins, heat sink, earthed soldering iron, pins 8 and 16 soldered first.

The probe tip housing on my prototype was turned from perspex and a 2 mm hole drilled through the centre. The probe tip wire is soldered to the end of a darning needle which is cemented into the housing with epoxy, allowing the needle to project about 15 mm beyond the end of the housing. It is not necessary to use a perspex cone, turned up as I have it. A flat-faced plug of a suitable material will suffice equally well.

Drill the 3mm holes for the LEDs at 10 mm intervals, starting 75 mm from the front of the case. The hole for the supply leads is drilled in the back of the

HOW IT WORKS ETI 148

Three of the six inverter/buffers in IC1 are used in the high/low detection circuit. IC1c is connected to the probe tip via R9. When the input goes HIGH (logic 1), IC1c output goes low and illuminates LED 2 through R5. Similarly when the input goes LOW (logic 0), the series pair IC1e and IC1f illuminate LED 1 through R4. The resistor network R1, R2 and R3 ensure that the outputs of both IC1c and IC1f remain high when the input is 'floating'. C1 is connected across R2 as a 'speed-up capacitor' to maintain a sharp pulse shape into IC1e and so improve the ability to follow high frequency pulse trains (over 1MHz).

The two inverters IC1a and b form a monostable circuit that stretches short pulses (less than 500 nsec) out to 15 msec (0.7RC) using C3 and R8. The input

of the monostable comes from the output of IC1c and is isolated from the DC level of this output by C2. The combination of R7 and D1 normally holds IC1b input high. When a negative going pulse is fed into IC1b through C2, the output goes high, forcing IC1a to go low and illuminate LED 3. Diode D1 ensures that the input to IC1b is kept low (0.7V above zero) so long as the output of IC1a remains low. This prevents subsequent pulses from retriggering IC1b until the monostable itself retriggers via discharge of C3 to earth through R8, and allows IC1a output to go high, switching off LED3.

Capacitors C4 and C5 (optional) confer immunity to spikes or pulses in the supply lines, which are taken from the circuit being tested.

case and fitted with a small rubber grommet (or plastic LED housing) to prevent the case rubbing through the insulation on the leads.

Before mounting the assembled pc board in the case check the circuit for dry joints, solder bridges, incorrectly mounted components, etc. Then test the device as follows. Connect to a five volt supply and observe the three LEDs. None should light with the probe tip isolated. If the LOW LED (LED 2) comes on or flashes, then R2 is too small and must be replaced by a slightly larger resistor (say 820 k). Touching the probe tip with the fingers may cause LED 2 to light, but this should go off when the tip is isolated. Touching the probe tip to either supply rail should light the appropriate LED, with the

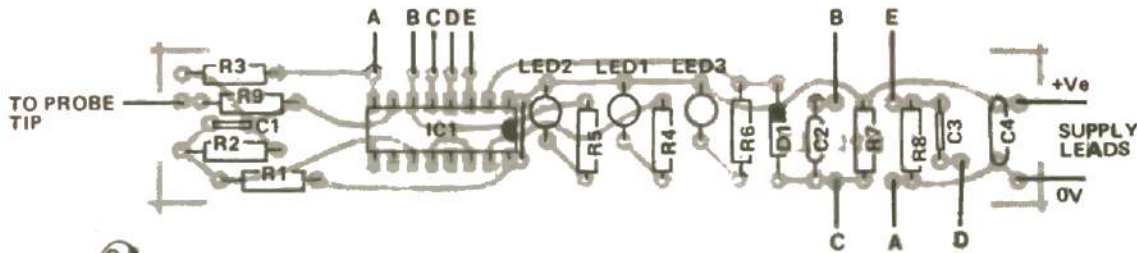

NOTE
C5 IF USED IS MOUNTED
ACROSS C4 (OBSERVE
POLARITY)

**CONNECT RESPECTIVE
LETTERS TOGETHER
A TO A B TO B etc.**

Component overlay for the pc board. Refer to the construction diagrams below for correct assembling of the LEDs.

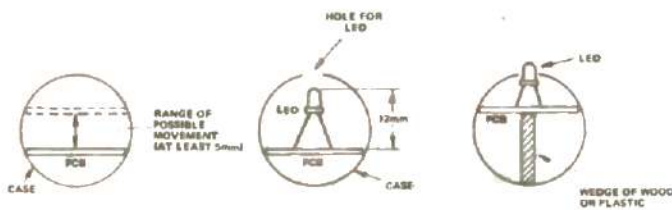
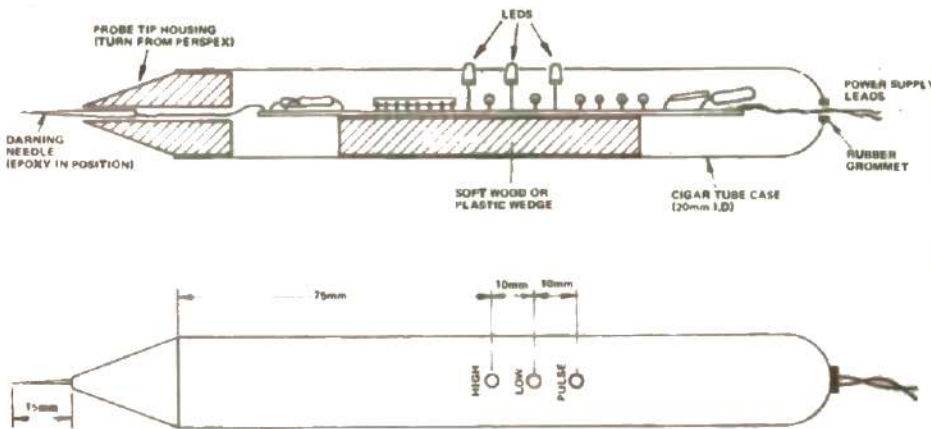
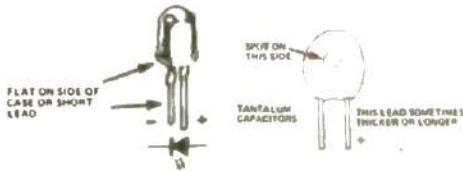

PARTS LIST - ETI 148

Resistors all 1/4W, 5%

- R1,7 . . . 2M2
- R2 680k*
- R3 560k*
- R4,5,6 . . . 820R
- R8 220k
- R9 1k

Capacitors

- C1,2 . . . 100p Ceramic
- C3 100n Greencap
- C4 10n Greencap
- C5 1μ Tantalum (Optional)

Semiconductors

- IC1 4049A
- LED 1,2 . . 3mm red
- LED 3 . . . 3mm green
- D1 1N4148 (or equivalent)

Miscellaneous

pcb; red and black leads with alligator clips or E-Z hooks;
cigar case (or equivalent) - minimum dimensions 20mm ID, 140mm long;
perspex rod for probe tip housing;
darning needle.

* Resistors R2 and R3 may have to be altered slightly (in the range 470k to 820k) to suit the transfer characteristics of IC1 - see text.

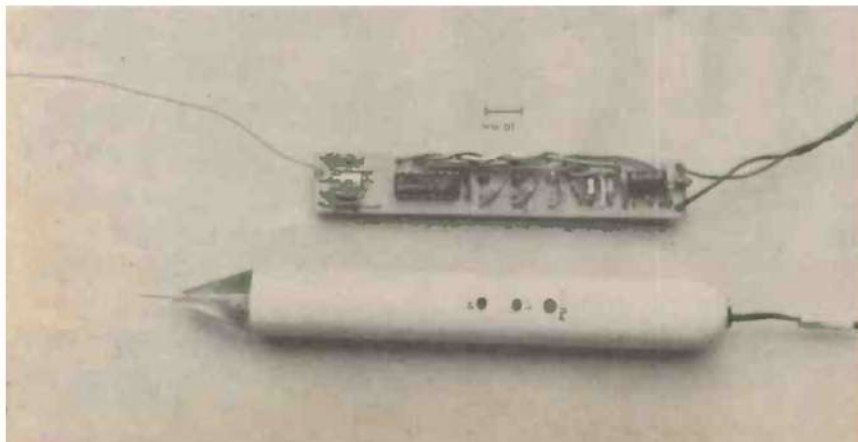

The printed circuit board is reproduced on page 148 or 149.

These diagrams above, and the picture left show the general construction of the probe and the drilling of the cigar tube or whatever case is used.

Project 148

PULSE LED flashing when the tip first touches the positive rail. If the LOW LED does not light when the probe is connected to 0V, then R2 is too large. Change R2 to 560k and repeat the sequence above.

Now try a 15 volt supply. Again, all LEDs should be extinguished when the probe tip is isolated. The HIGH LED (LED 1) may glow very faintly. If this glow is too strong, reduce the value of R3 to say 470k. However, if R3 has to be altered it will be necessary to recheck the circuit at 5V to see that the low voltage performance is still satisfactory. At 15 volts repeat the process of touching the probe tip to the two supply rails. The results should be the same as in the case of the 5 volt supply, but the LEDs will be considerably brighter.

When satisfied that the circuit works correctly mount it in the case. First, cover the edges of the pc board with strips of tape to insulate it from the case and apply a thin smear of epoxy cement around the base of each LED. Feed the power supply leads through the back of the case, followed by the assembled board. Jockey the board into a position where the LEDs are directly under the

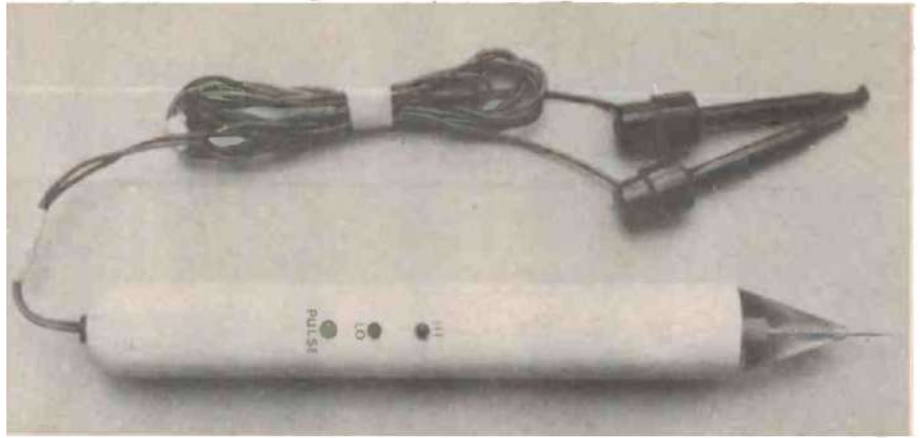

The completed logic probe.

holes in the case and then push the assembly up into a position so that the LEDs protrude through the holes in the case. The epoxy around the base of the LEDs will anchor them in position. In addition to this means of holding the board in place, a small wedge of soft wood, plastic or similar insulating material can be inserted into the space between the bottom of the board and

the case. The probe tip and its plastic housing is then inserted in the front of the case and epoxied in position.

When the epoxy has set, fit the clips or E-Z hooks to the ends of the supply leads, label the three LEDs and give the whole instrument a coat of protective lacquer. The completed logic probe is now ready for use — but don't forget to smoke the cigar! ●